



Клеци с кръгла челюст и резец (клеци с дълги челюсти и извити върхове)

DIN ISO 5745



26 11 200

Полирана глава, еднокомпонентни ръкохватки



26 12 200

Полирана глава, двукомпонентни ръкохватки



26 13 200

Хромирана челюст, еднокомпонентни ръкохватки



26 15 200

Хромирана челюст, двукомпонентни ръкохватки





26 16 200

Хромирана челюст, двукомпонентни ръкохватки, VDE проверени

IEC 60900 DIN EN 60900



26 17 200

Хромирана челюст, Дръжки изолирани с потапяне, изпитани по VDE

IEC 60900 DIN EN 60900

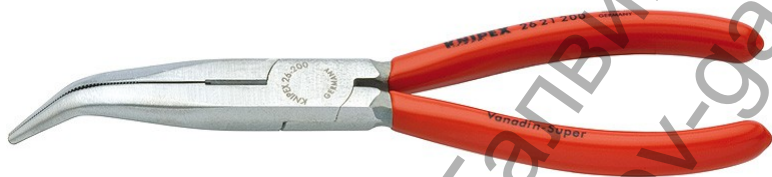

26 21 200

Полирана глава, еднокомпонентни ръкохватки



26 22 200

Полирана глава, двукомпонентни ръкохватки



26 25 200

Хромирана челюст, двукомпонентни ръкохватки



26 26 200

Хромирана челюст, двукомпонентни ръкохватки, VDE проверени

IEC 60900 DIN EN 60900

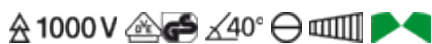

26 27 200

Хромирана челюст, Дръжки изолирани с потапяне, изпитани по VDE





IEC 60900 DIN EN 60900

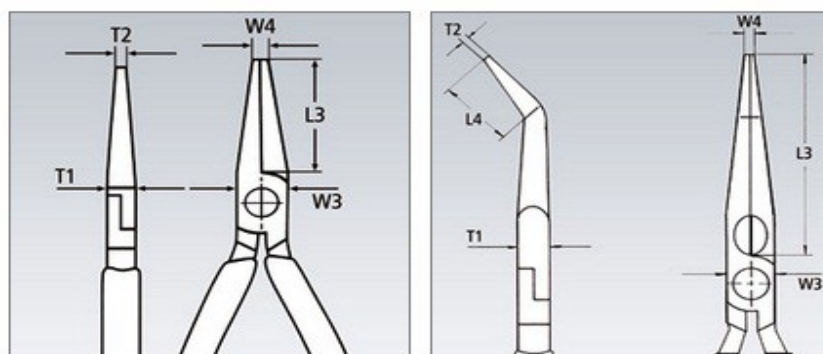

- [Описание](#)
- [Приложение](#)
- [Технически чертеж](#)
- Еластични върхове: стабилна форма дори при усукване
- Еластични челюсти, прецизни върхове
- плоско-кръгли, дълги, заострени челюсти
- с резци (твърдост около 61 HRC) за рязане на мека, средно твърда и твърда тел
- Ванадиева електростомана, изковани, закалени в масло





Артикулен номер	EAN 4003773-			L3 mm	L4 mm	T1 mm	W3 mm	W4 mm	T2 mm		
		Ø mm	Ø mm								
26 11 200	022824	3,20	2,20	73,00		9,50	17,50	3,00	2,50	200	170
26 12 200	023142	3,20	2,20	73,00		9,50	17,50	3,00	2,50	200	201
26 13 200	040590	3,20	2,20	73,00		9,50	17,50	3,00	2,50	200	169
26 15 200	035022	3,20	2,20	73,00		9,50	17,50	3,00	2,50	200	198
26 16 200	022831	3,20	2,20	73,00		9,50	17,50	3,00	2,50	200	206
26 17 200	016069	3,20	2,20	73,00		9,50	17,50	3,00	2,50	200	212
26 21 200	022848	3,20	2,20	73,00	23,00	9,50	17,50	3,00	2,50	200	171
26 22 200	023135	3,20	2,20	73,00	23,00	9,50	17,50	3,00	2,50	200	197
26 25 200	035039	3,20	2,20	73,00	23,00	9,50	17,50	3,00	2,50	200	199
26 26 200	022855	3,20	2,20	73,00	23,00	9,50	17,50	3,00	2,50	200	204
26 27 200	016090	3,20	2,20	73,00	23,00	9,50	17,50	3,00	2,50	200	220

Запазено право за технически изменения и несъответствия

Ташерън ООД
www.tashern.com